

TMT AO & Possible Contribution of Japan

Hideki Takami (Subaru Telescope)

Subsystems Mounted on Telescope

(TMT document)

Red: Possible Japanese collaboration

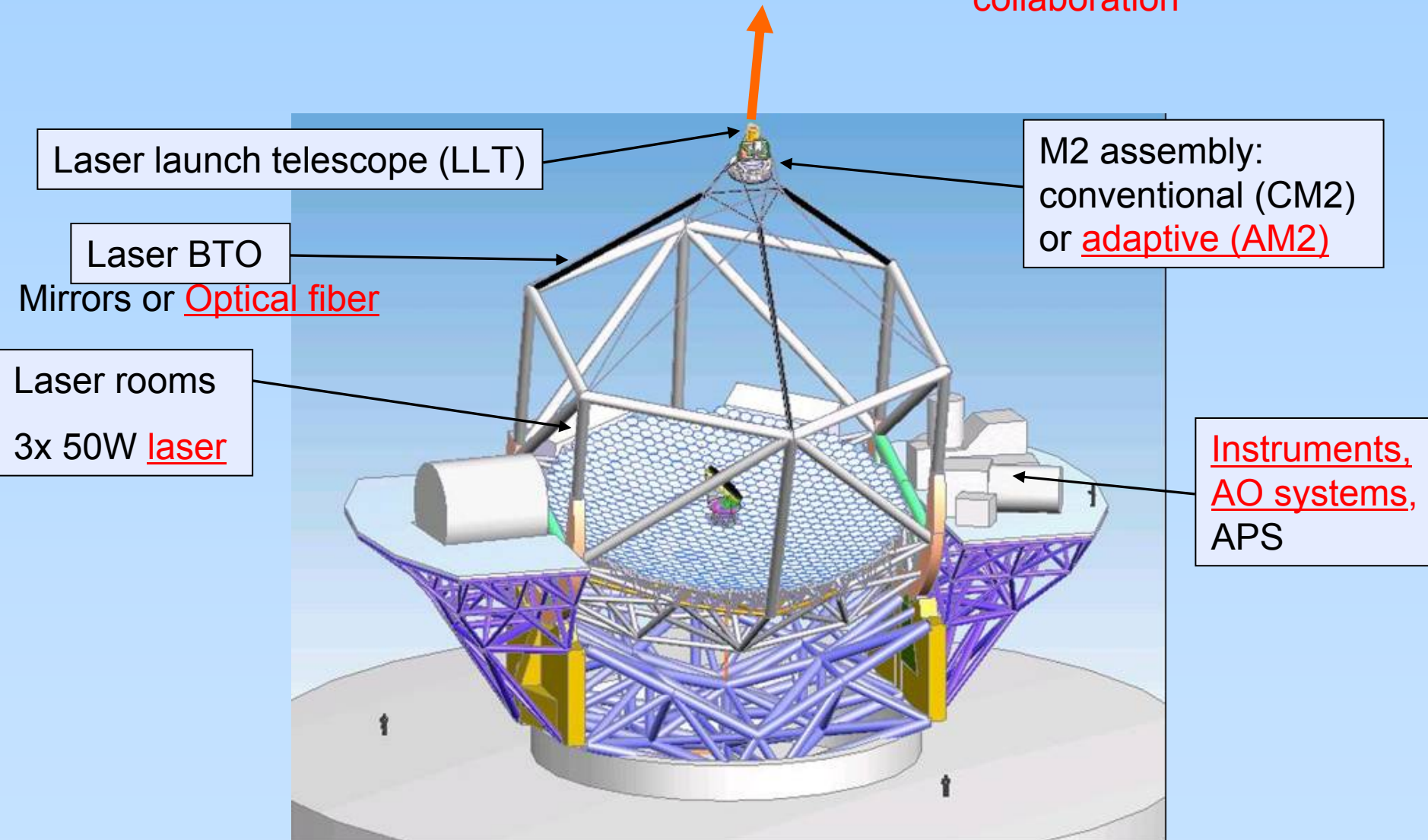

TMT-Mapping AO Modes to Instrumentation Capabilities (TMT document)

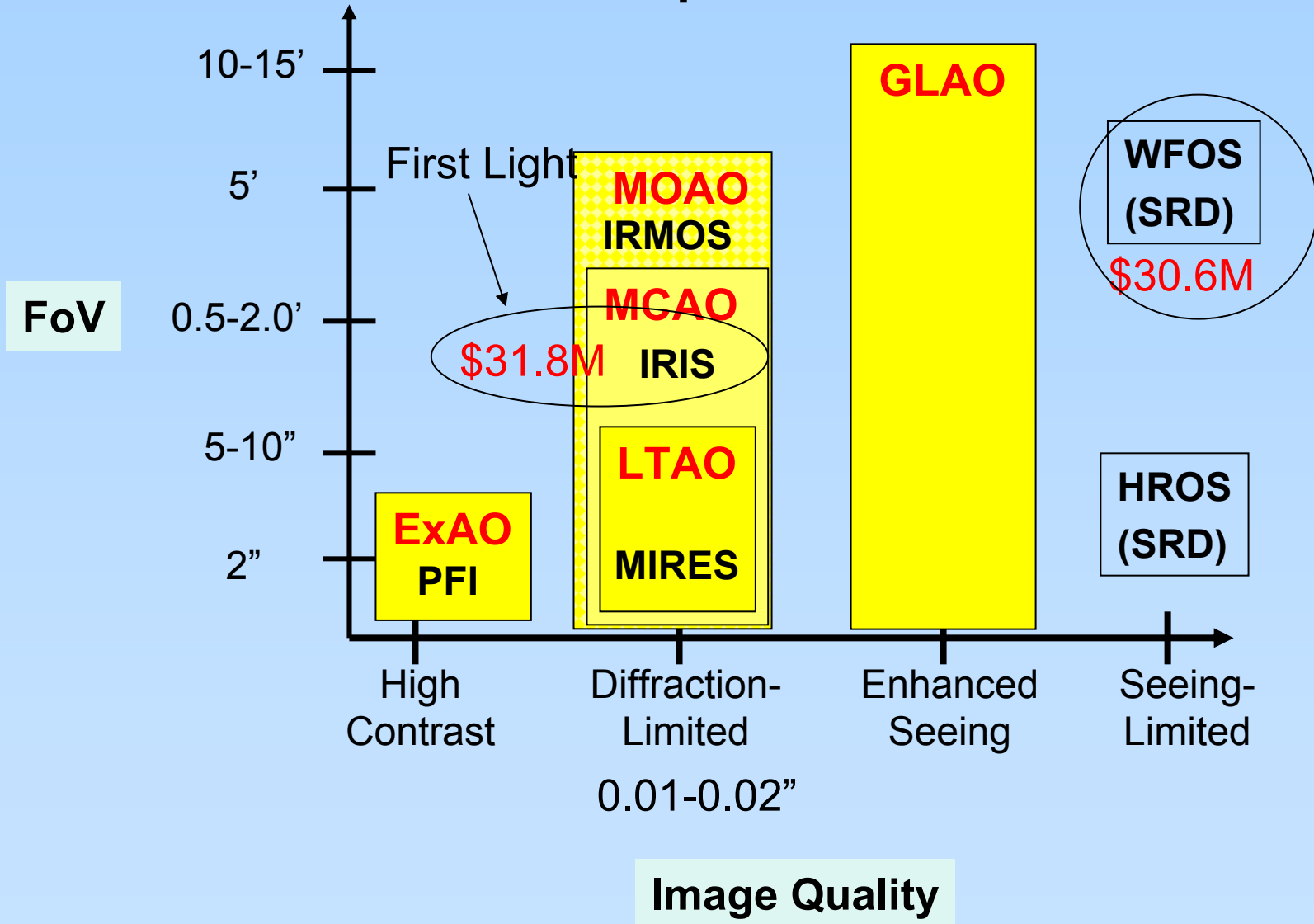

First Light AO Architecture for TMT

Supports Narrow-Field Instruments Using

Existing/Near-Term Components/Concepts (TMT document)

2011 FDR

2016 Commission

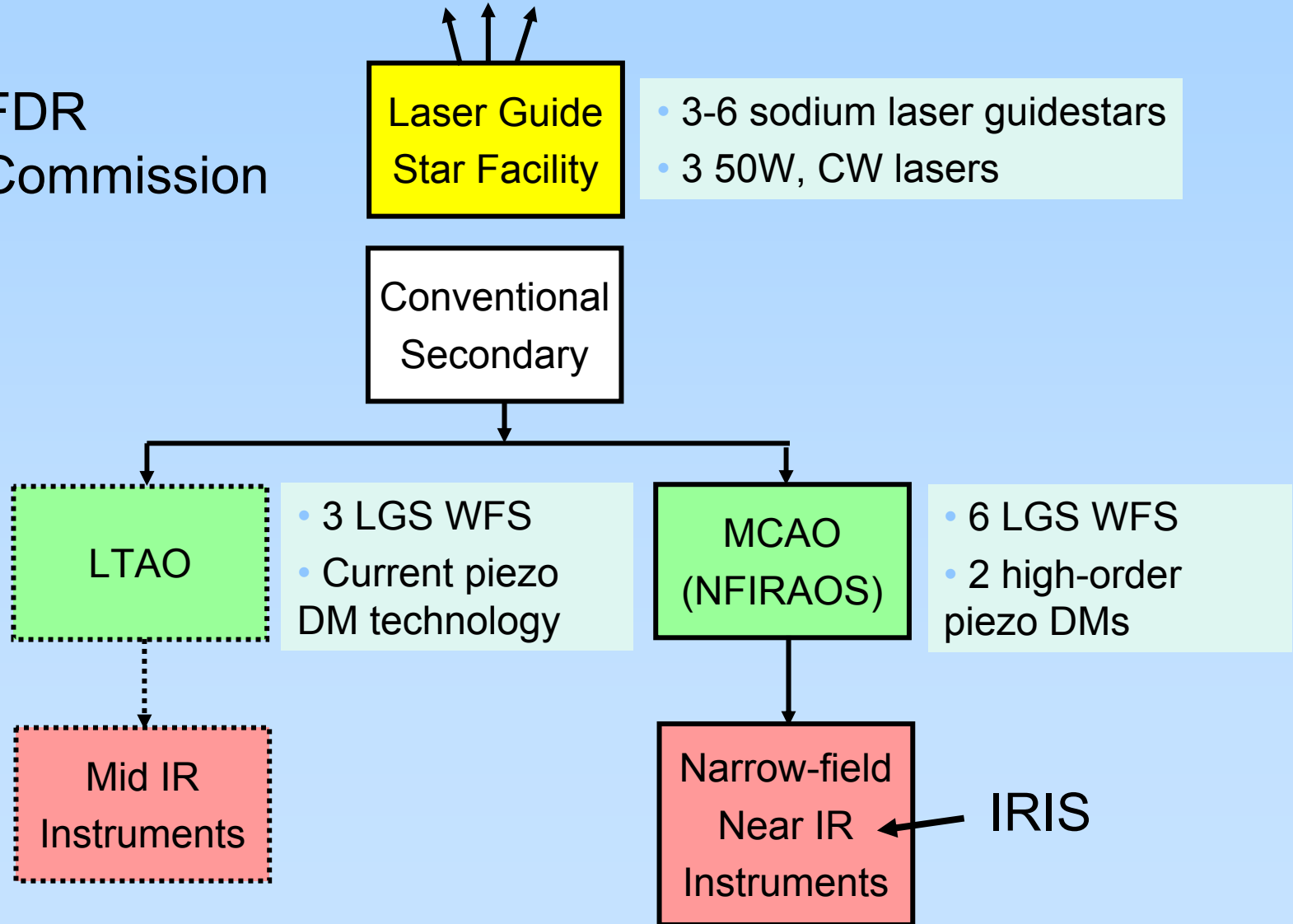

An Adaptive Secondary Mirror Enables GLAO for Wider-Field Instruments and Improves Performance for Mid IR Instruments

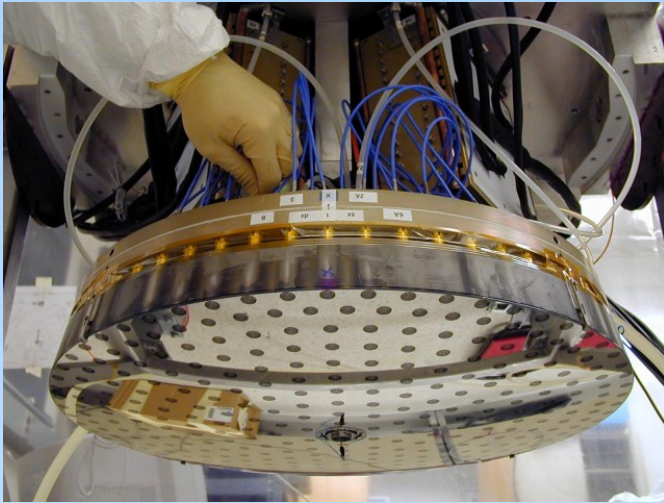

(TMT document)

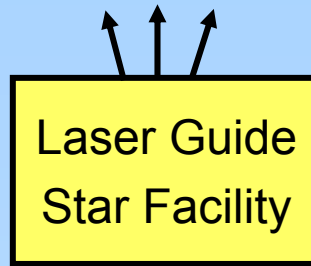

- Compensation at moderate spatial and temporal frequencies for low-order correction or woofer-tweeter control

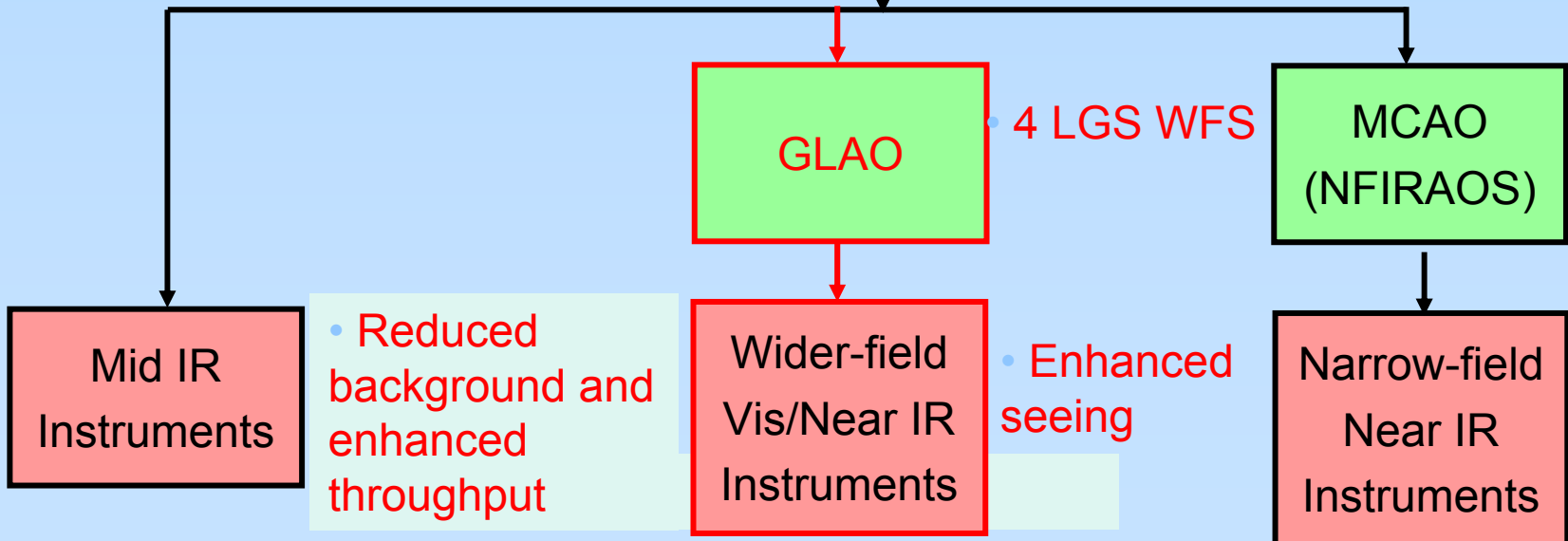

MEMs Deformable Mirrors Enable MOAO for Enhanced Imaging and Spectroscopy of Multiple Small Objects within a Larger Field

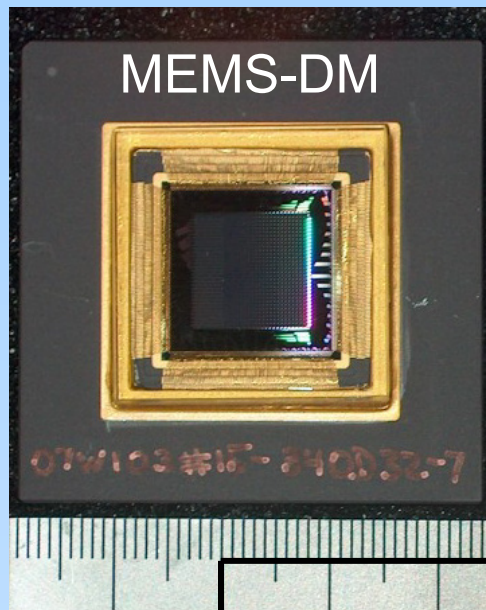

(TMT document)



- 8 sodium laser guidestars
- 3 50W, CW lasers

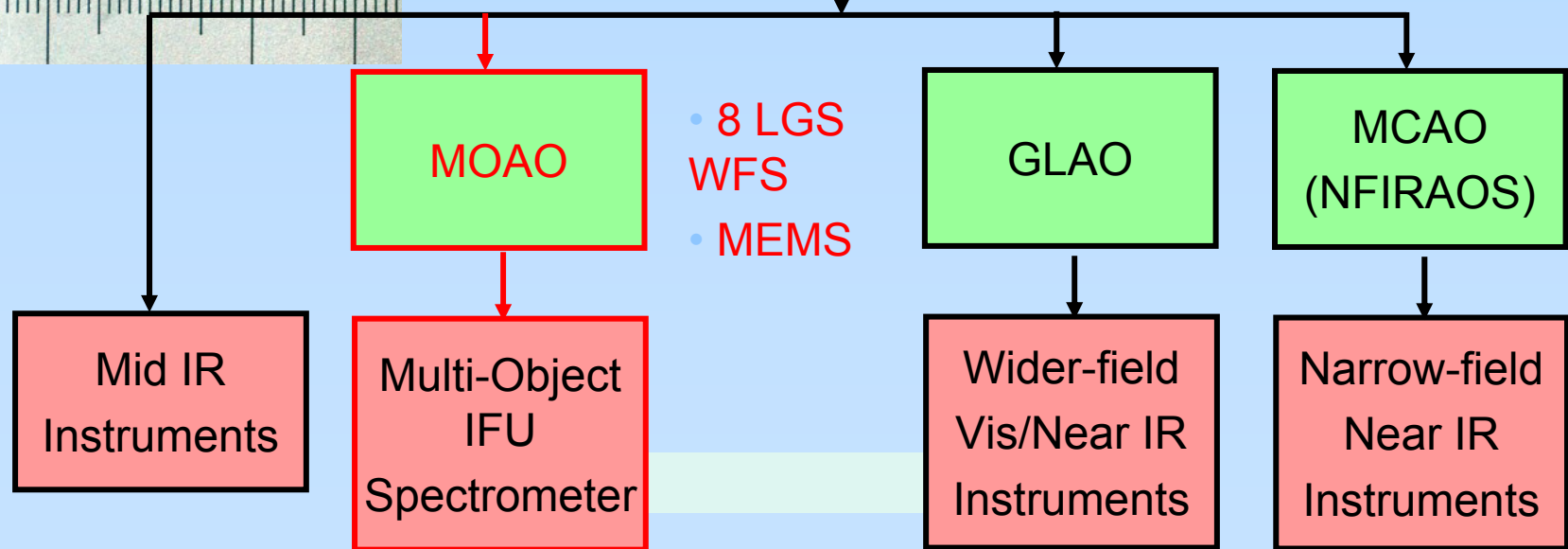

First light AO: IRIS will be mounted on the top port of NFIRAOS (TMT document)

◆ NFIRAOS is a dual conjugate AO system => Wide Field (~2')

Order 61x61 DM and TTS at h=0 km

Order 75x75 DM at h=12 km

– Better Strehl and larger field than current AO systems

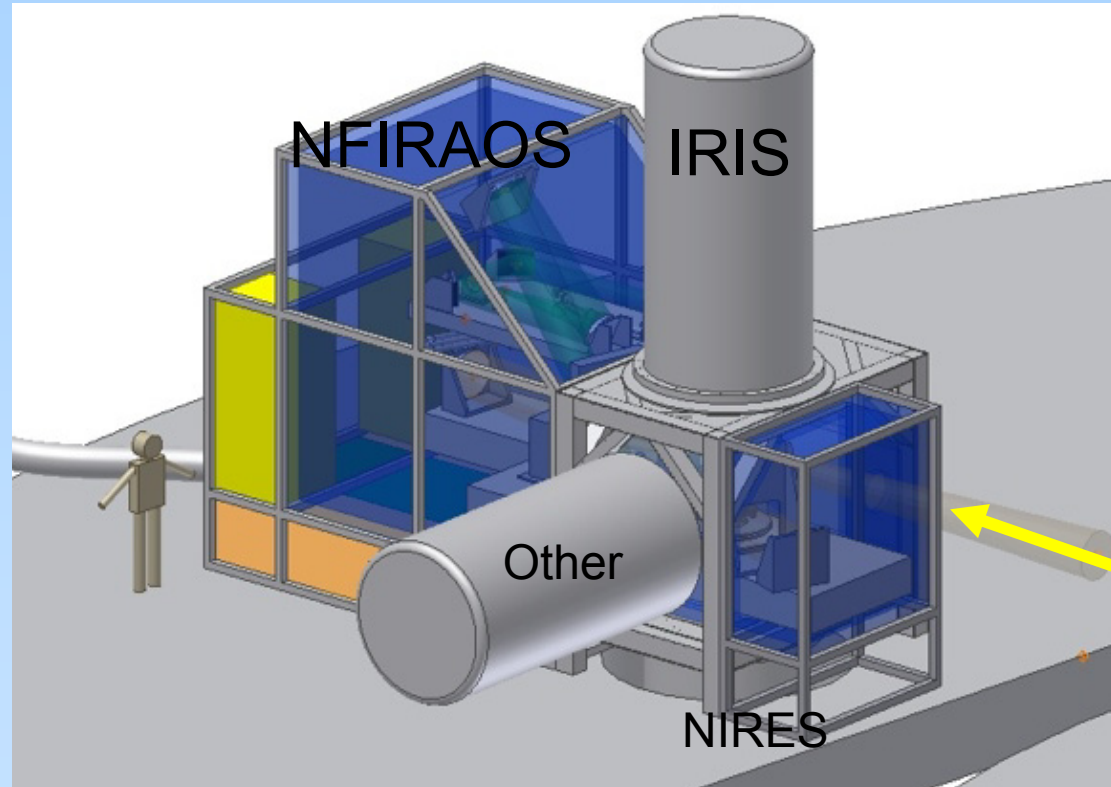

Schematic of INSTRUMENT Activity (TMT document)

	2009	2010	2011	2012	2013	2014	2015	2016	2017	2018	2019	2020	2021
WFOS			FDR			TES T		CO MM					
IRIS		PDR	FDR			NFI RAO S		CO MM					
INST 3			CoD R		PDR		FDR			CO MM			
INST 4			CoD R					FDR			CO MM		
INST 5						CoD R	PDR		FDR				CO MM
INST 6						CoD R	PDR			FDR			
INST 7									CoD R	PDR		FDR	
INST 8									CoD R	PDR			FDR

Possible collaboration items with TMT about AO

Red: Possible Japanese
collaboration

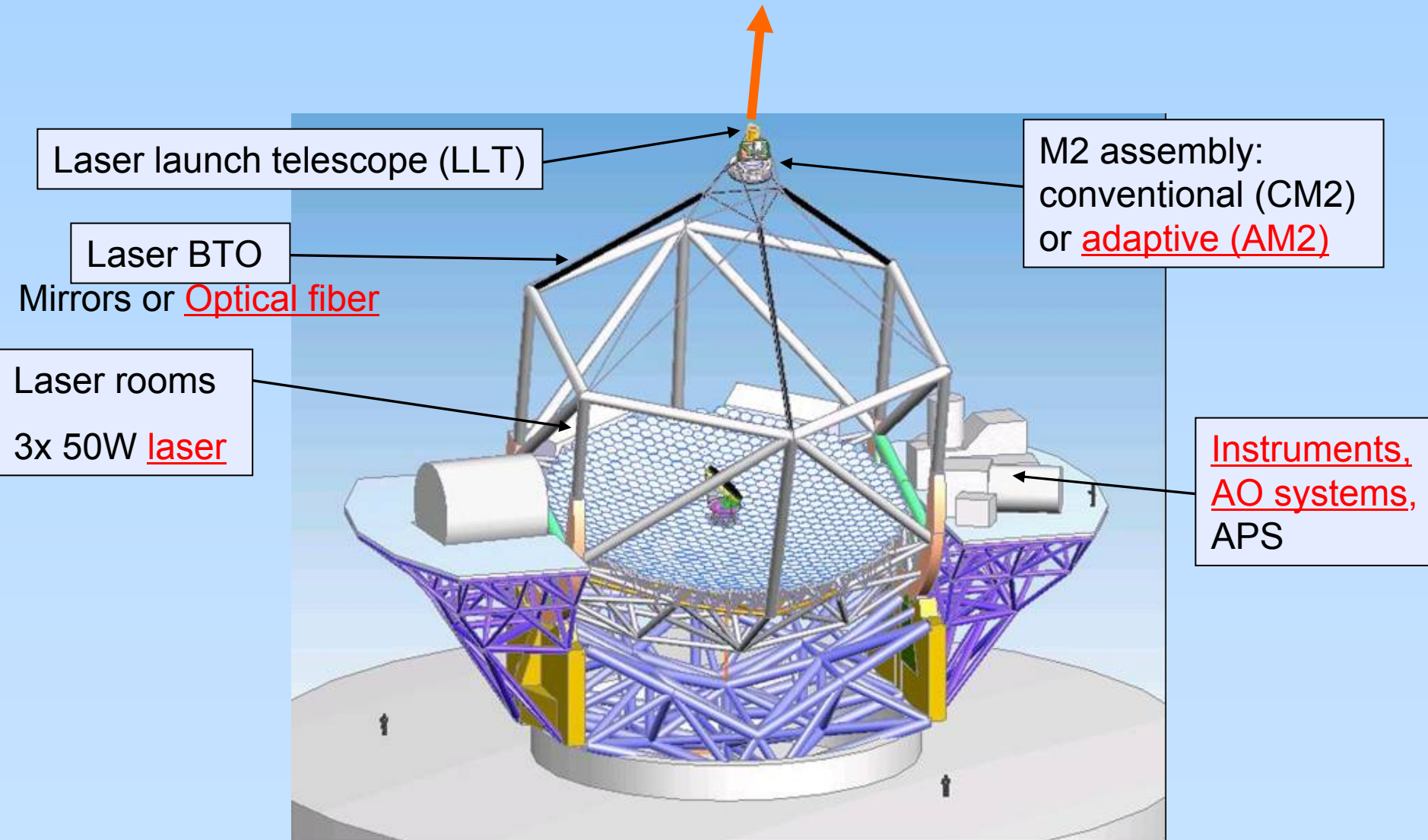

Adaptive 2ry

Requirements of AM2 for TMT

- 1800 actuator, 400 modes,
- 3.1 m diameter, convex mirror
- 4-5 mm thickness glass (7 cm spacing)
- 20 Hz BW (AO closed loop BW -3dB),
- good for MIR AO or woofer, +/- 150 um (end to end, for windshake and chopping)

AM2 is not fit in construction budget, upgrade 4-5 year after the first light. ~2020

=> Japanese industry is expected as the manufacturer

First light AO collaboration in discussion with TMT

1. Laser & Fiber

- TMT now has a candidate vendor of Laser. As for Japan's contribution, 10 W CW laser is OK, however required 25 W is new area for us.
=> Considering the TMT first light is 2016, It is worth to discuss with them.
- Fiber: Mitsubishi-cable (We will collaborate)
Our 35m fiber is almost meet the requirement of TMT

2. RTC for NFIRAOS (continue discussion)

GRAPE would be a candidate. TMT has a pre-conceptual design to use 3 DSP and 7 FPGA. Those chips have limitation in memory size.

Requirement to the performance of Core part

- Input/output 120k pixel in 0.5 msec/WFS x 6WFSs
- gradient computation etc 35k grad for 6WFSs (it is smaller than others)
- 175M multiply & accumulation /frame in ~1ms => FFT & spars matrix op.
- 7400 actuators drive, 2DMs 61x61, 73x73

2008-2009 conceptual design study.

2013 mid delivery of RTC

Summary

1. TMT covers wide range of AO in their plan
2. TMT will build only one LGSAO system for their First light.
3. Japan has possible collaboration technologies to contribute their FL AO (The contribution would be subsystem or component level, good for starting?)
4. Other several Instruments/AO require additional budget which will be commissioned in 2018-2022

(We have a chance to make significant contributions and should have ideas what we want to do)